

LEGEND

BLACK color is for standard accessories coming with SmartGuider2 camera.

BLUE color is for optional accessories to be purchased separately.

SMARTGUIDER²

with MGA device

LVI ACCESSORIES CHART

Last Update: Mar. 03, 2010

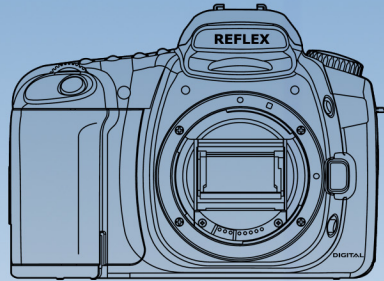

BRAND	MODEL
CANON	20D, 20DA, 30D, 40D, 50D, 5D, 7D 10 Mark II, 10s Mark II, 10 Mark III, 1Ds Mark III, 10 Mark IV, 5D Mark II

BRAND	MODEL
CANON	300D, 350D, 400D, 450D, 500D, 550D, 1000D
PENTAX	*ist, *istD, *istDL, *istDL2, *istDs, K100D, K110D, K110D, K20D, K200

BRAND	MODEL
NIKON	D200, D300, D300s, D700, D1, D1H, D1X, D2Xs, D2X, D2H D3, D3X, F5, F6, F90, F90X, F100
FUJIFILM	S3PRO, S5PRO

BRAND	MODEL
SONY	α100, α200, α300, α350, α500, α550, α700, α850, α900
MINOLTA	Dynax 5D, 7D - DIMAGE 3, 4, 5, 7, 7i, 7Hi, 9

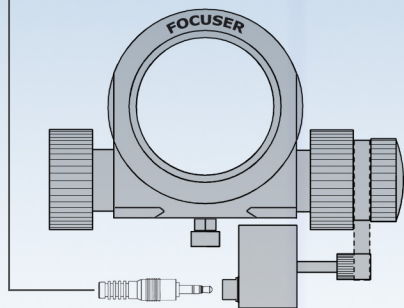
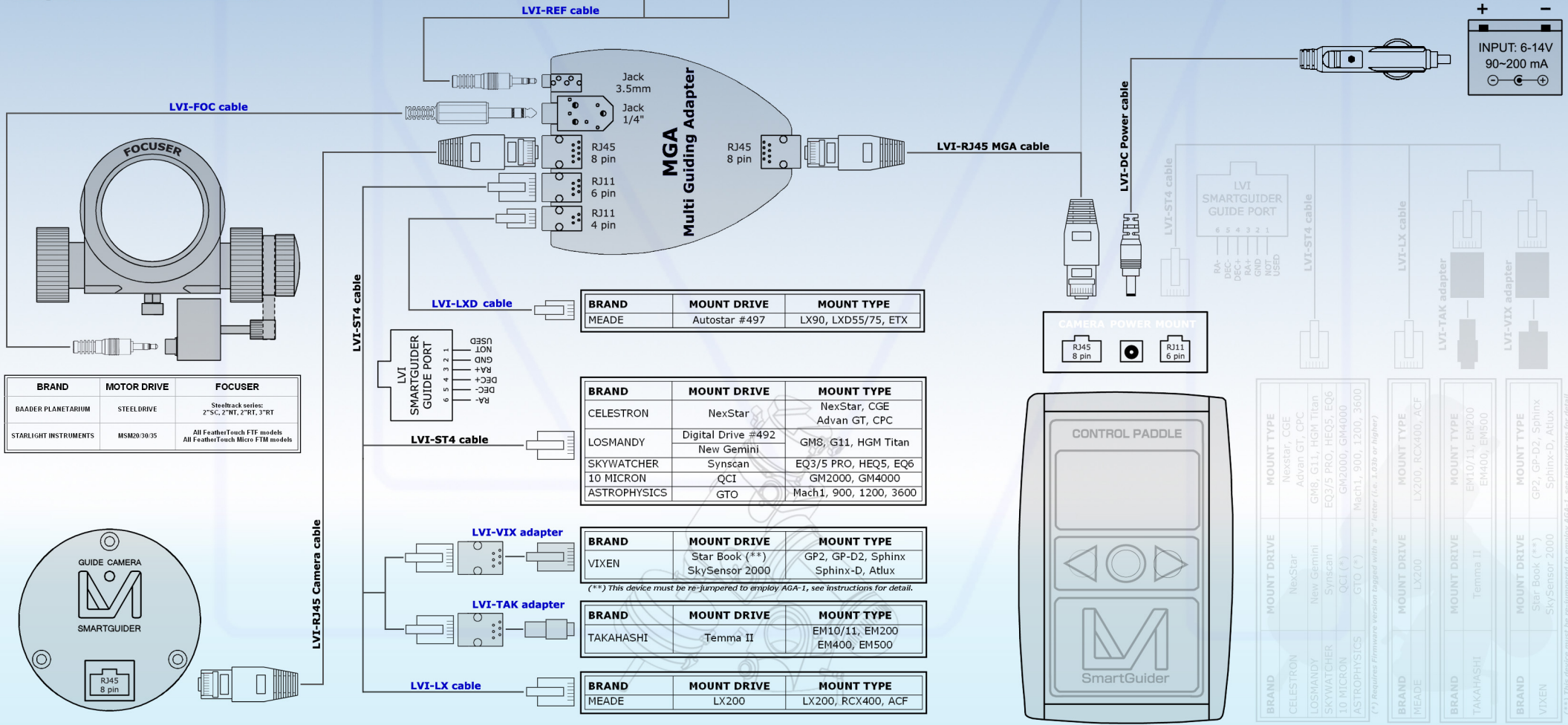

BRAND	MOTOR DRIVE	FOCUSER
BAADER PLANETARIUM	STEEL DRIVE	Steeltrack series: 2" SC, 2" HI, 2" RT, 3" FT
STARLIGHT INSTRUMENTS	MSM20/30/35	All FeatherTouch FT* models All FeatherTouch Micro FTM models

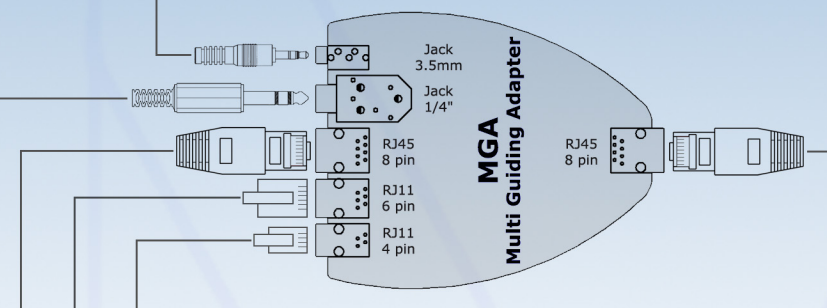
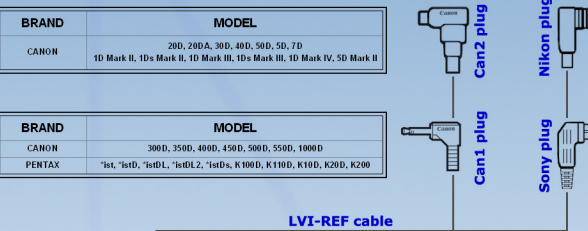
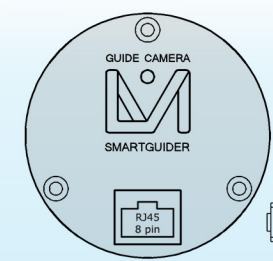

BRAND	MOUNT DRIVE	MOUNT TYPE
MEADE	Autostar #497	LX90, LXD55/75, ETX
CELESTRON	NexStar	NexStar, CGE Advan GT, CPC
LOSMANDY	Digital Drive #492	GMS, G11, HGM Titan
SKYWATCHER	Synscan	EQ3/5 PRO, HEQ5, EQ6
10 MICRON	QCI (*)	GM2000, GM4000
ASTROPHYSICS	GTO	Mach1, 900, 1200, 3600
VIXEN	Star Book (**)	GP2, GP-D2, Sphinx Sphinx-D, Atlux
TAKAHASHI	Temma II	EM10/11, EM200 EM400, EM500
MEADE	LX200	LX200, RCX400, ACF

(**) This device must be re-jumpered to employ AGA-1, see instructions for detail.

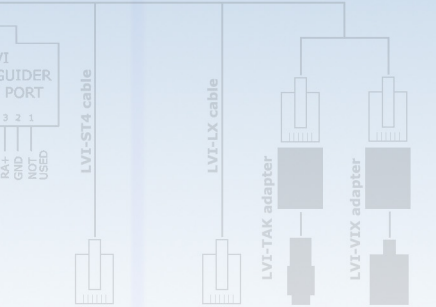
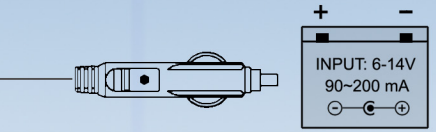
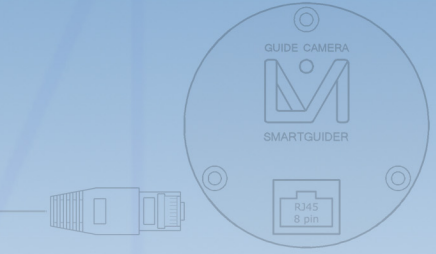
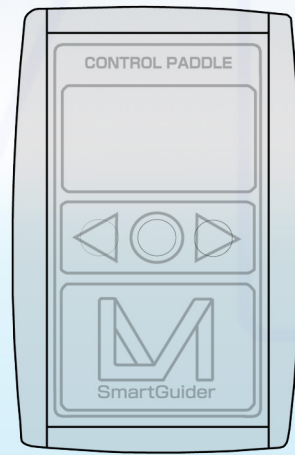
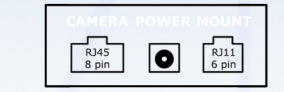

BRAND	MOUNT DRIVE	MOUNT TYPE
CELESTRON	NexStar	NexStar, CGE Advan GT, CPC
LOSMANDY	New Gemini	GMB, G11, HGM Titan
SKYWATCHER	Synscan	EQ3/5 PRO, HEQ5, EQ6
10 MICRON	QCI (*)	GM2000, GM4000
ASTROPHYSICS	GTO (*)	Mach1, 900, 1200, 3600
BRAND	MOUNT DRIVE	MOUNT TYPE
MEADE	LX200	LX200, RCX400, ACF
TAKAHASHI	Temma II	EM10/11, EM200 EM400, EM500
VIXEN	Star Book (**)	GP2, GP-D2, Sphinx SkySensor 2000

(*) Requires firmware version 1.03 or higher.

(**) This device must be re-jumpered to employ AGA-1, see instructions for detail.